

WIMPOLE_{St} | ROOM GUIDES



Room Guide:

Guy Whittle Auditorium

The Guy Whittle Auditorium is a purpose-built room with comfortable gently tiered leather seating. The room boasts cameras and recording equipment for video production and online streaming. Ideal for presentations, lectures, professional development seminars, product launches, press conferences, exams and AGMs. Each chair has a pull-out writing desk for a classroom-style set-up and the walls are fitted with wooden acoustic 'Gustav' panelling. The auditorium also offers convenient wheelchair access within the audience seating or onto the stage.

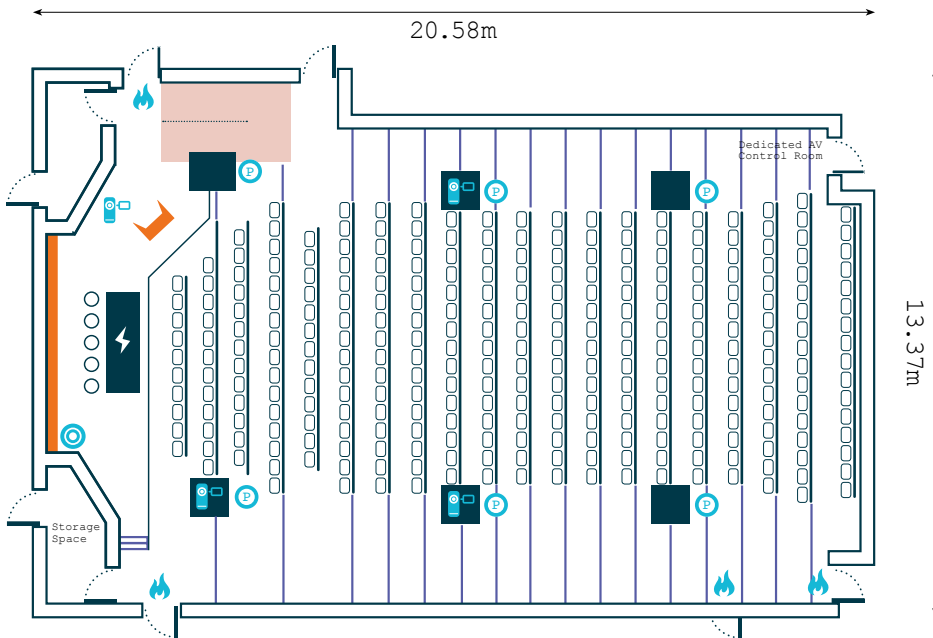

Dimensions

Length: 20.58m
 Width: 13.37m
 Height(highest point): 3.54m
 Screen size: 6.44 x 3.15

Capacities

Theatre: 298

Key Items Included In Room Hire

- Assistive listening systems
- Colour LED lighting
- Confidence monitors
- Dedicated AV technician and control room
- 4K Ultra high definition, high contrast projector
- Internet access with Wi-Fi
- Laser pointer/clicker
- Lectern
- PA system with wireless microphones
- Presenters preparation area with live feed from auditorium
- Pull out writing tablets on all chairs
- Top table

- | | | | |
|--|----------------------------------|--|------------------|
| | Climate Control | | Pillar |
| | Fire Exit | | Power Point |
| | Power Plug | | Projector Screen |
| | Video Camera | | Glass Window |
| | Lectern with Interactive Monitor | | Step |



Room Guide: Max Rayne Auditorium

The Max Rayne Auditorium has luxurious tiered leather seats facing a purpose-built stage, perfect for a conference, lecture, presentation, professional development seminar, product launch, press conference, or AGM. The room boasts cameras and recording equipment for video production, broadcast and online streaming. The room is fully accessible, with two conveniently located wheelchair spaces at the front of the room and the walls are fitted with wooden acoustic 'Gustav' panelling.

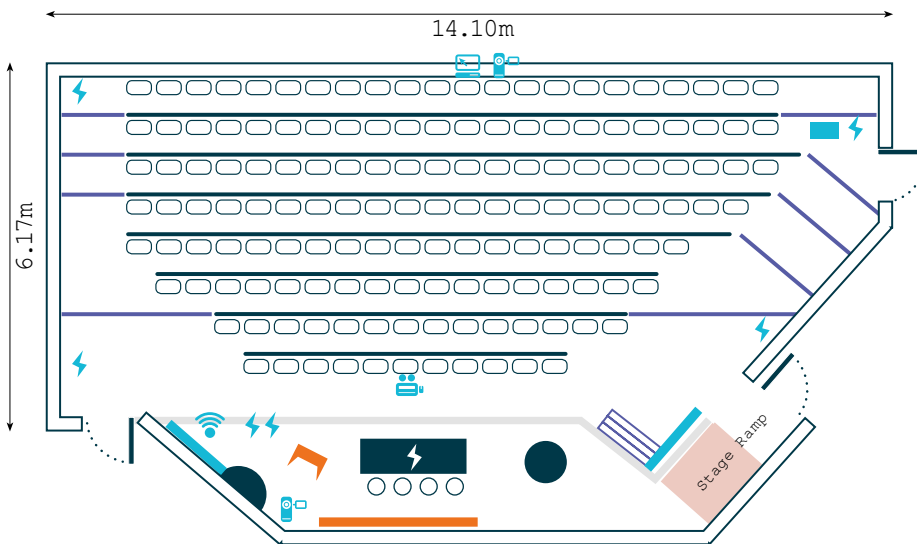

Dimensions













Length: 14.10m
Width: 6.17m
Height(highest point): 3.38m
Screen size: tbc

Capacities

Theatre: 148

Key Items Included
In Room Hire

- Assistive listening systems
- Colour LED lighting
- Confidence monitors available
- Dedicated AV technician and control desk
- High definition, high brightness projector
- Internet access with Wi-Fi
- Laser pointer/clicker Lectern
- PA system with wireless microphones
- Top table

	65" Confidence monitor		Lectern with Interactive Monitor
	Power Plug		Technician Desk with AV technician
	Wired Internet Access		Pillar
	Video Camera		LCD Screen
	Projector		Projector Screen
	Light Control		Step



Room Guide:

Naim Dangoor Auditorium

The Naim Dangoor Auditorium is a purpose-built tiered lecture theatre facing a flat-floored stage area and a multi-display screen perfect for branding and social media feeds. The room boasts cameras and recording equipment for video production, hybrid events and live streaming. Ideal for presentations, lectures, professional development seminars, product launches, press conferences and AGMs. Up to 6 wheelchairs can be accommodated in the front row. This room has the facility to offer natural daylight or for a more formal presentation, use the electronic black-out blinds.

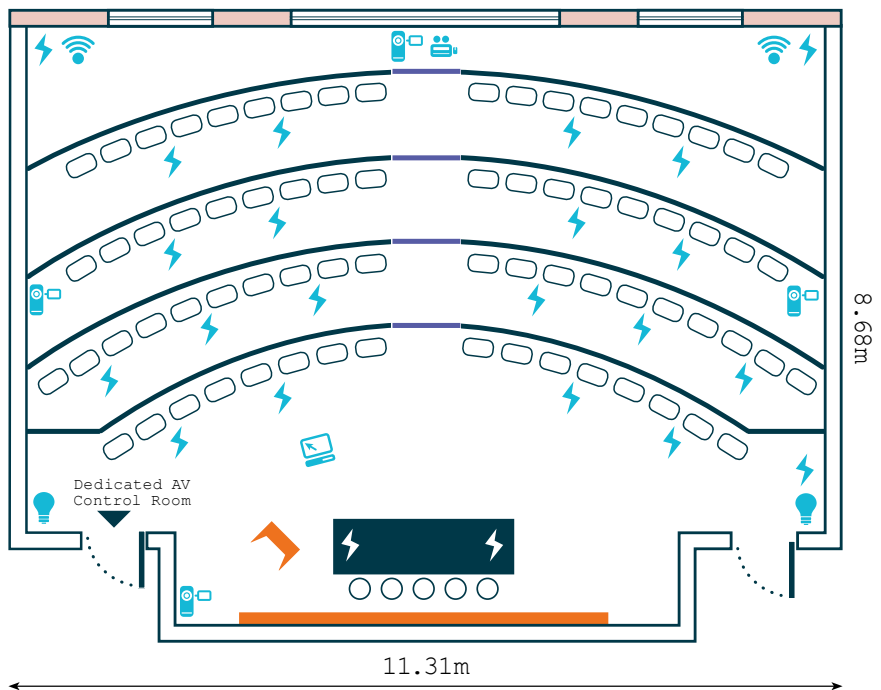

Dimensions

Length: 11.31m
 Width: 8.68m
 Height(highest point): 5.20m
 Screen size: 2.64 x 1.47

Capacities

Theatre: 69

Key Items Included In Room Hire

- Assistive listening systems
- Colour LED lighting
- Confidence monitors
- Dedicated AV technician and control room
- High definition, high brightness projector
- Internet access with Wi-Fi
- Laser pointer/clicker
- Lectern
- PA system with wireless microphones
- Presenters preparation area with live feed from auditorium
- Top table

- | | | | |
|--|------------------------|--|----------------------------------|
| | 65" Confidence monitor | | Light Control |
| | Power Plug | | Lectern with Interactive Monitor |
| | Wired Internet Access | | Projector Screen |
| | Video Camera | | Glass Window |
| | Projector | | Step |



Room Guide:

Max Rayne Atrium

A stunning room flooded with natural daylight from the vaulted glass roof and surrounding walls. This offers an outside-inside feel when the weather can be temperamental and is a beautiful setting both during the day and at night. This versatile room is perfect for drinks receptions, conference dining and exhibitions.

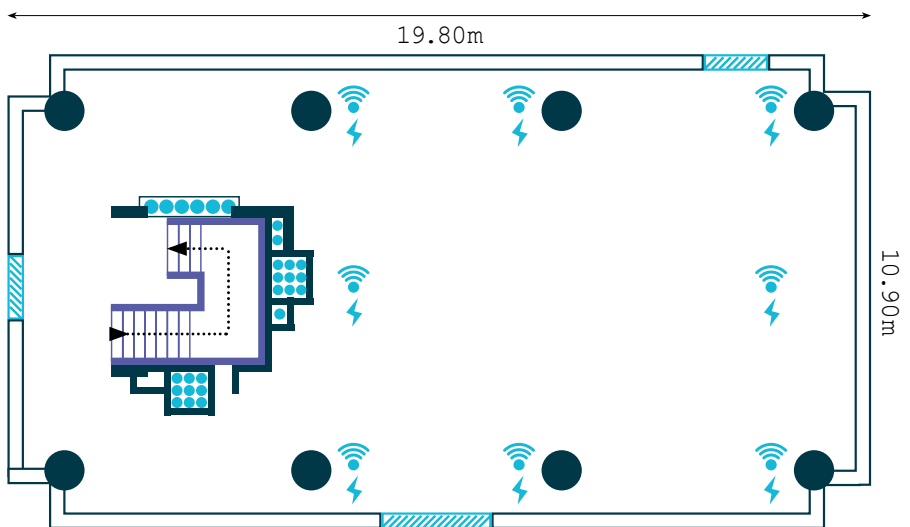

Dimensions







Length: 19.80m
 Width: 10.90m
 Height(highest point): 8.69m

Capacities

Reception: 200
 Standing Buffet: 170
 Seated Buffet: 66

Key Items Included
 In Room Hire

- Internet access with Wi-Fi
- Vaulted glass ceiling
- PA system for background music

- | | | | |
|---|-----------------------|---|--------------|
|  | Power Plug |  | Glass Window |
|  | Wired Internet Access |  | Step |
|  | Pillar |  | Plants |
|  | Glass Doors | | |



Room Guide:

The Cavendish Room

An elegant, multi-purpose conference dining, social event and exhibition space for up to 150 people in a range of styles including reception drinks, buffets, banquets, and exhibitions. It is also used as a separate catering area if you're having a conference in one of the lecture theatres and it is fully wheelchair accessible, located close to the auditoriums on the ground floor.

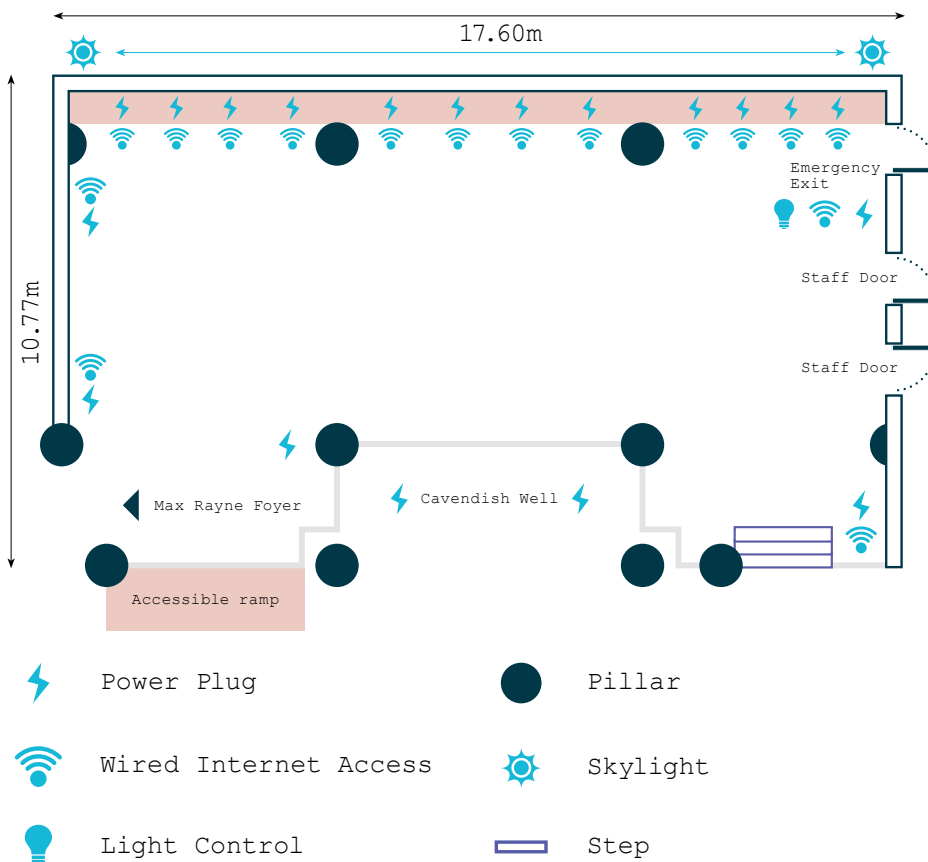

Dimensions

Length: 17.60m
 Width: 10.77m
 Height(highest point): 3.30m

Capacities

Reception: 200
 Standing Buffet: 150
 Seated Buffet: 100

Key Items Included In Room Hire

- Bar with cabled internet access
- Internet access with Wi-Fi



Room Guide:

Toynbee Mackenzie ENT Room

This is a striking, wood-panelled event and exhibition space that's imbued with the rich medical heritage of our building. Named after Joseph Toynbee and Morell Mackenzie, two pioneers of Ear, Nose and Throat (ENT) medicine, it houses a fascinating display of ENT medical equipment. This room offers a full range of set-up styles for conference dining and exhibitions linking directly with the Max Rayne Foyer. Perfect for drinks receptions, exhibitions or formal dining. A bonus feature is the bright terrace and raised catering area, and it is wheelchair accessible thanks to its ground floor location.

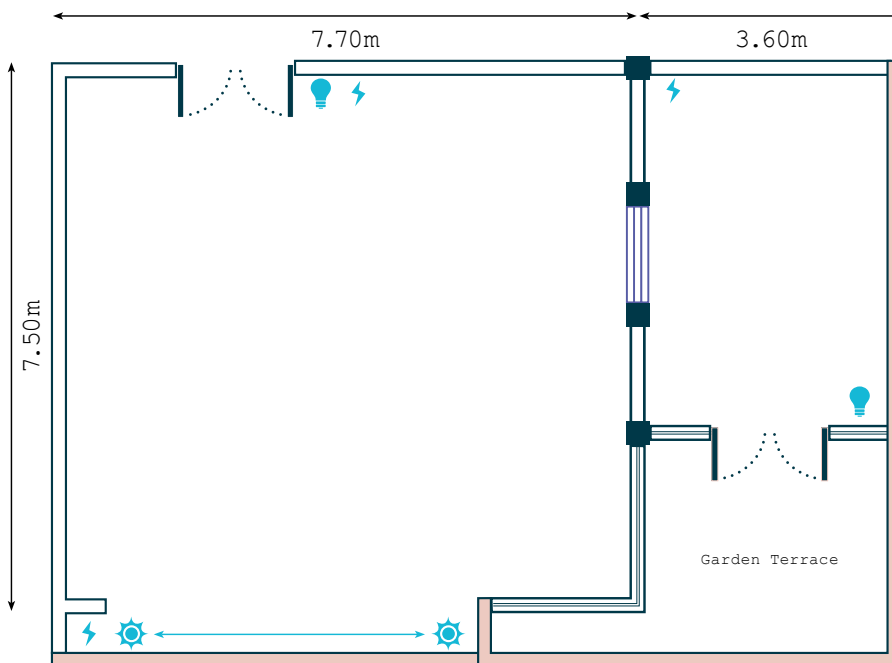

Dimensions

Length: 11.30m

Width: 7.50m

Height(highest point): 2.99m

Capacities

Classroom: 25

Theatre: 24

Boardroom: 24

Cabaret: 32

Reception: 50

Standing Buffet: 50

Seated Buffet: 40

U Shape: 20

Key Items Included

In Room Hire

- Internet access with Wi-Fi
- Raised catering area
- Small garden terrace
- Wood-panelling throughout

 Light Control

 Pillar

 Power Plug

 Glass Window

 Skylight

 Step



Room Guide: Max Rayne Foyer

This flat floored room is conveniently located on the ground floor next to the Max Rayne Auditorium. It works well as a catering or exhibition area, located next to the ENT Room, offering a larger space when booked together.

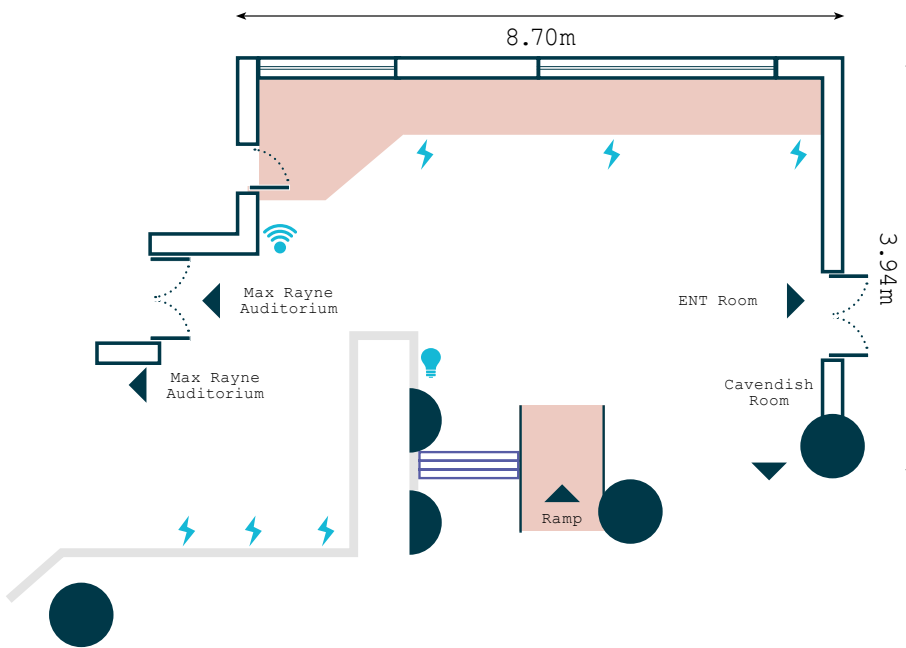

Dimensions

Length: 8.70m
Width: 3.94m
Height(highest point): 2.99m

Capacities

Reception: 80
Standing Buffet: 60
Seated Buffet: 40

Key Items Included

In Room Hire

- Catering area
- Internet access with Wi-Fi

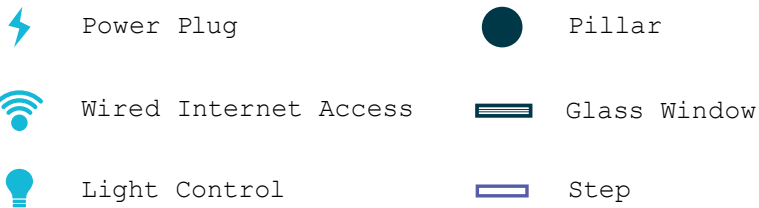



Room Guide: Wimpole Room

Located within the RSM's Members' area and available for hire stand-alone meetings, training or presentations. It can also be booked as a separate room for a business breakfast, an VIP dinner, a business lunch or drinks reception. The room also has a dividing wall that can facilitate separate workshop rooms seating up to 12 people in each.

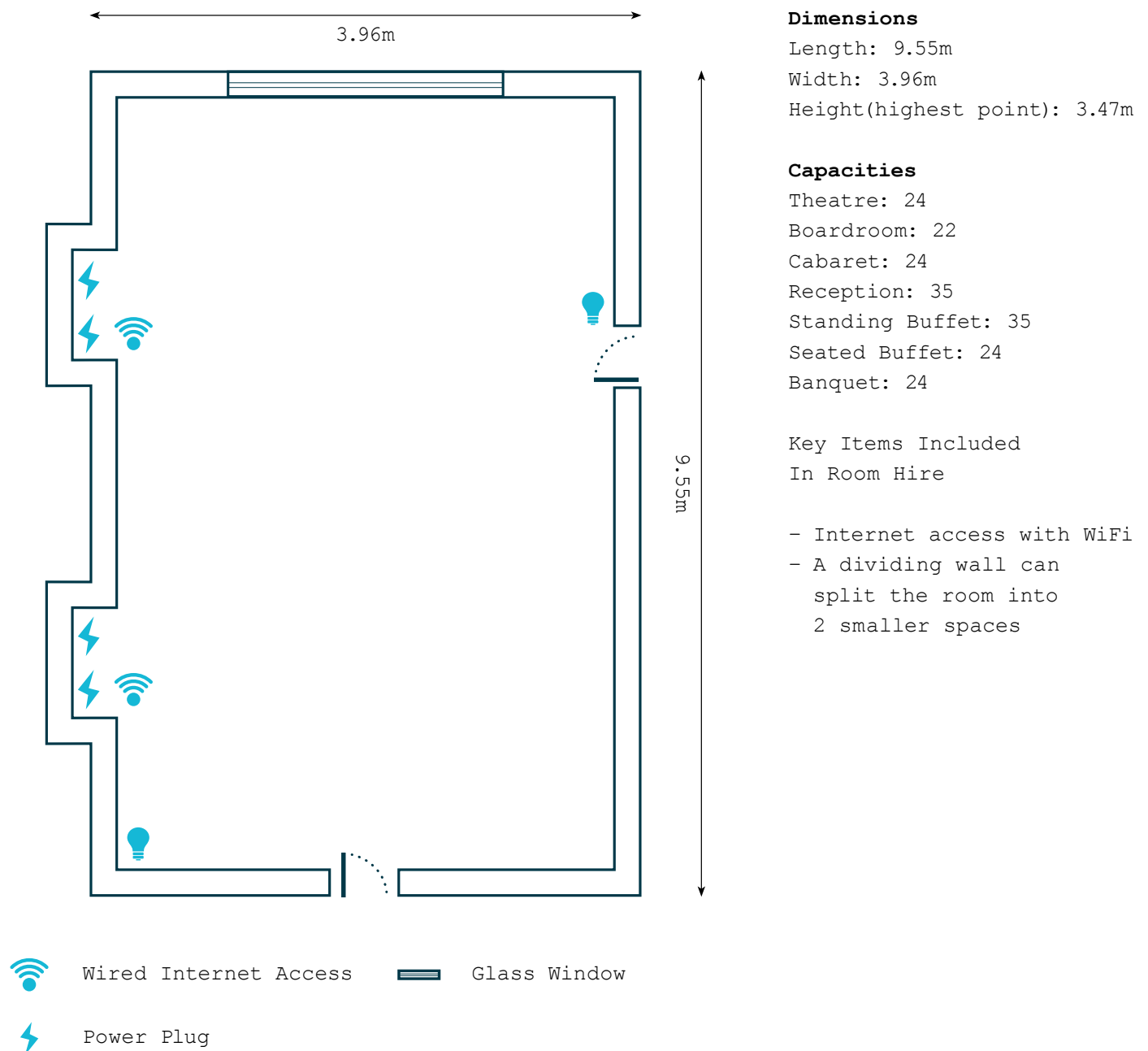



Room Guide:

Hewitt Room

Located within the RSM's Members' area and available for hire for stand-alone meetings, training or presentations. It can also be booked as a separate room for a business breakfast, a VIP dinner, a business lunch or intimate drinks reception.

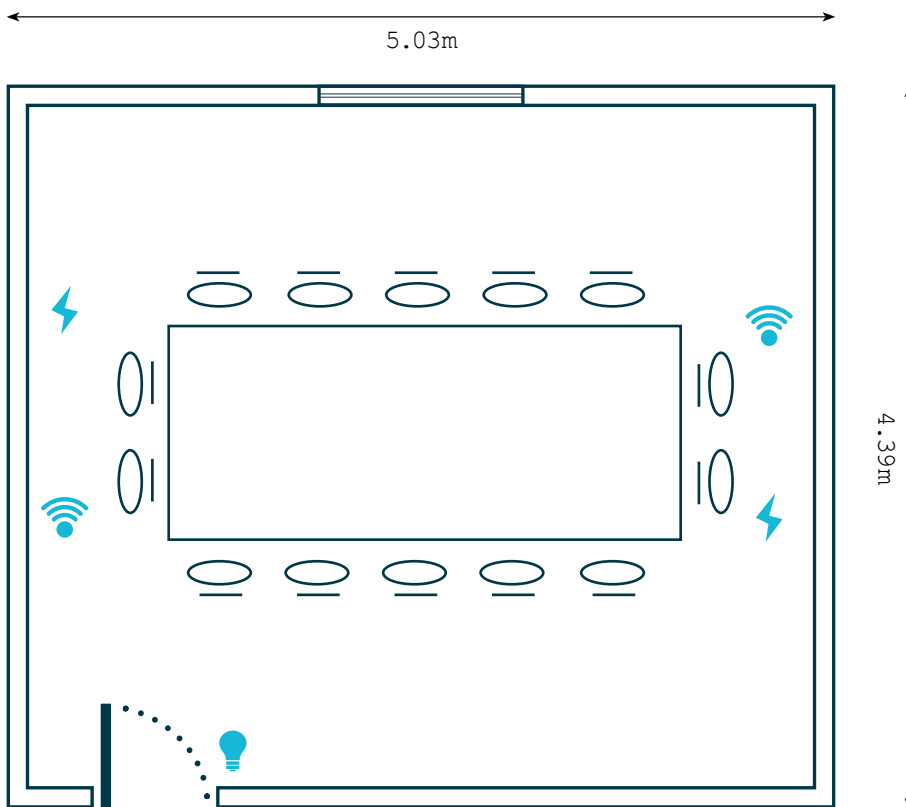

Dimensions

Length: 5.03m

Width: 4.39m

Height(highest point): 2.37m

Capacities

Boardroom: 14

Seated Buffet: 14

Key Items Included

In Room Hire

- Internet access with WiFi

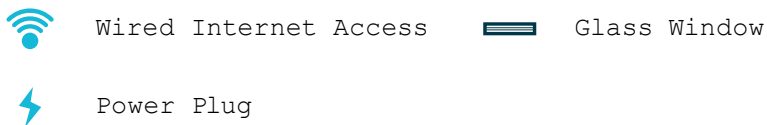



Room Guide: Training Suite

A flexible room with air conditioning, partition wall for separate breakout sessions, a wipe-clean floor and a sink, making it suitable for interactive medical training days.

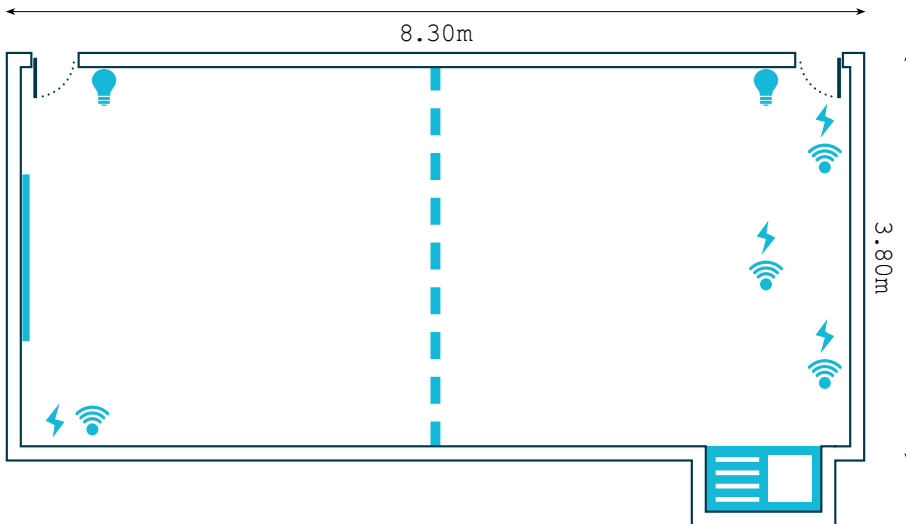

Dimensions

Length: 8.30m
Width: 3.80m
Height(highest point): 2.20m

Capacities

Classroom: 14
Theatre: 25
Boardroom: 16
Standing Buffet: 20
Cabaret: 12

Key Items Included In Room Hire

- Projector and 80" screen
- Internet access with Wi-Fi
- Lectern
- Partition wall
- Sink
- Wipe clean floor

- | | |
|--|--|
|  Power Plug |  Sink Area |
|  Wired Internet Access |  Moveable Wall |
|  Light Control |  80" LCD Screen |



Room Guide: Seminar Room 1

Seminar Room 1 is one of a trio of interconnecting rooms that can flex to fit your meeting requirements. Decorated in a contemporary style and handily fitted with removable walls, it can be used alone or in combination with Seminar Room 2 and Seminar Room 3 for a larger capacity. It holds up to 15 people in a full range of setups: boardroom, theatre, reception, and standing buffet. Hence it's perfectly suited for hosting all manner of seminars, interviews and business meetings. Seminar Room 1 is located next to our Training Suite, which makes a great breakout space if you need a workshop or catering area for a training day.

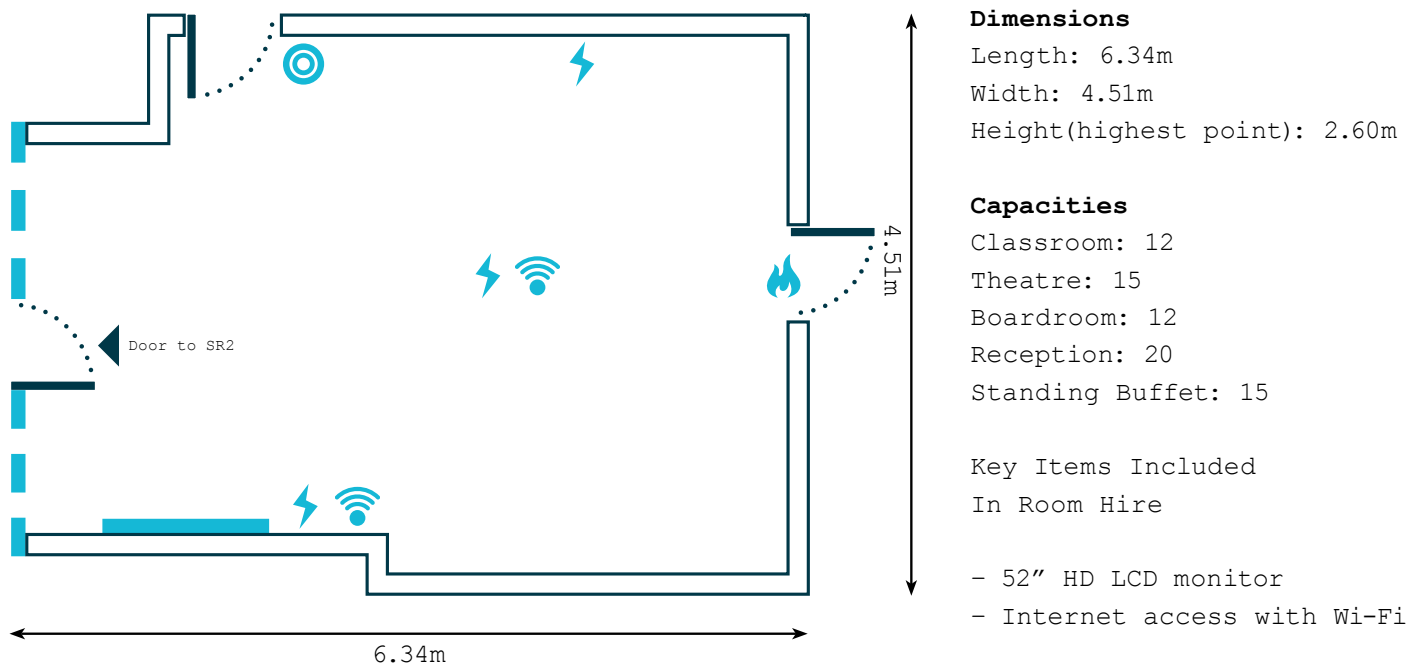

Dimensions

Length: 6.34m

Width: 4.51m

Height(highest point): 2.60m

Capacities

Classroom: 12

Theatre: 15

Boardroom: 12

Reception: 20

Standing Buffet: 15

Key Items Included

In Room Hire

- 52" HD LCD monitor

- Internet access with Wi-Fi

 Climate Control

 Wired Internet Access

 Fire Exit

 LCD Screen

 Power Plug

 Moveable Wall

 Phone available



Room Guide: Seminar Room 2

Seminar Room 2 is one of a trio of interconnecting rooms that can flex to fit your meeting requirements. Decorated in a contemporary style and handily fitted with removable walls, it can be used alone or in combination with Seminar Room 1 and Seminar Room 3 for a larger capacity. It holds up to 20 people in a full range of setups: boardroom, theatre, reception, and standing buffet. It's thus perfect for holding all manner of seminars, interviews and business meetings. Seminar Room 2 is located next to our Training Suite, which makes a great breakout space if you need a workshop or catering area for a training day.

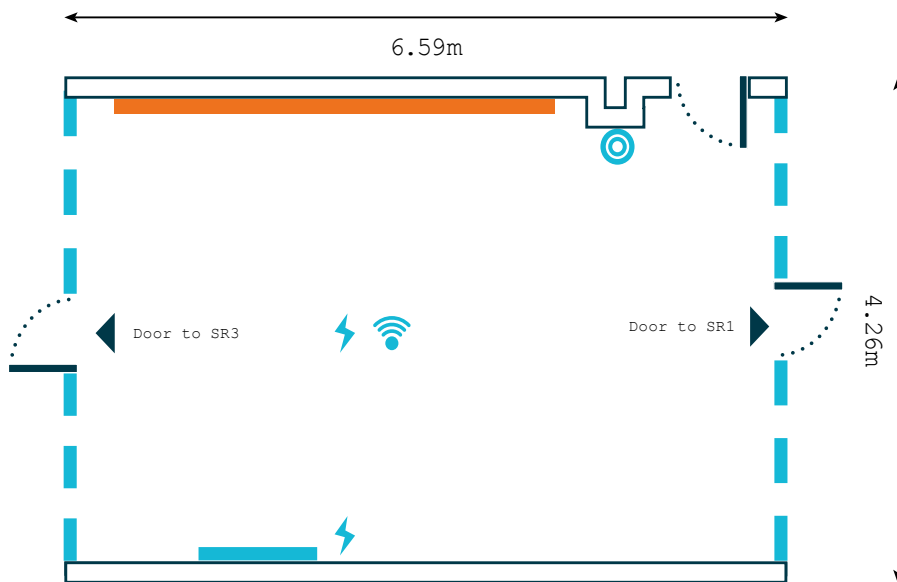

Dimensions

Length: 6.59m
Width: 4.26m
Height(highest point): 2.60m

Capacities

Classroom: 14
Theatre: 25
Boardroom: 14
Reception: 20
Standing Buffet: 15

Key Items Included In Room Hire

- 52" HD LCD monitor
- Internet access with Wi-Fi

- | | | | |
|--|-----------------------|--|----------------|
| | Climate Control | | LCD Screen |
| | Power Plug | | Dry Wipe Board |
| | Wired Internet Access | | Moveable Wall |
| | Phone available | | |



Room Guide: Seminar Room 3

Seminar Room 3 is one of a trio of interconnecting rooms that can flex to fit your meeting requirements. Decorated in a contemporary style and handily fitted with removable walls, it can be used alone or in combination with Seminar Room 1 and Seminar Room 2 for a larger capacity. It holds up to 24 people in a full range of setups: boardroom, theatre, reception, and standing buffet. It's therefore perfect for holding all manner of seminars, interviews and business meetings. Seminar Room 2 is located next to our Training Suite, which makes a great breakout space if you need a workshop or catering area for a training day.

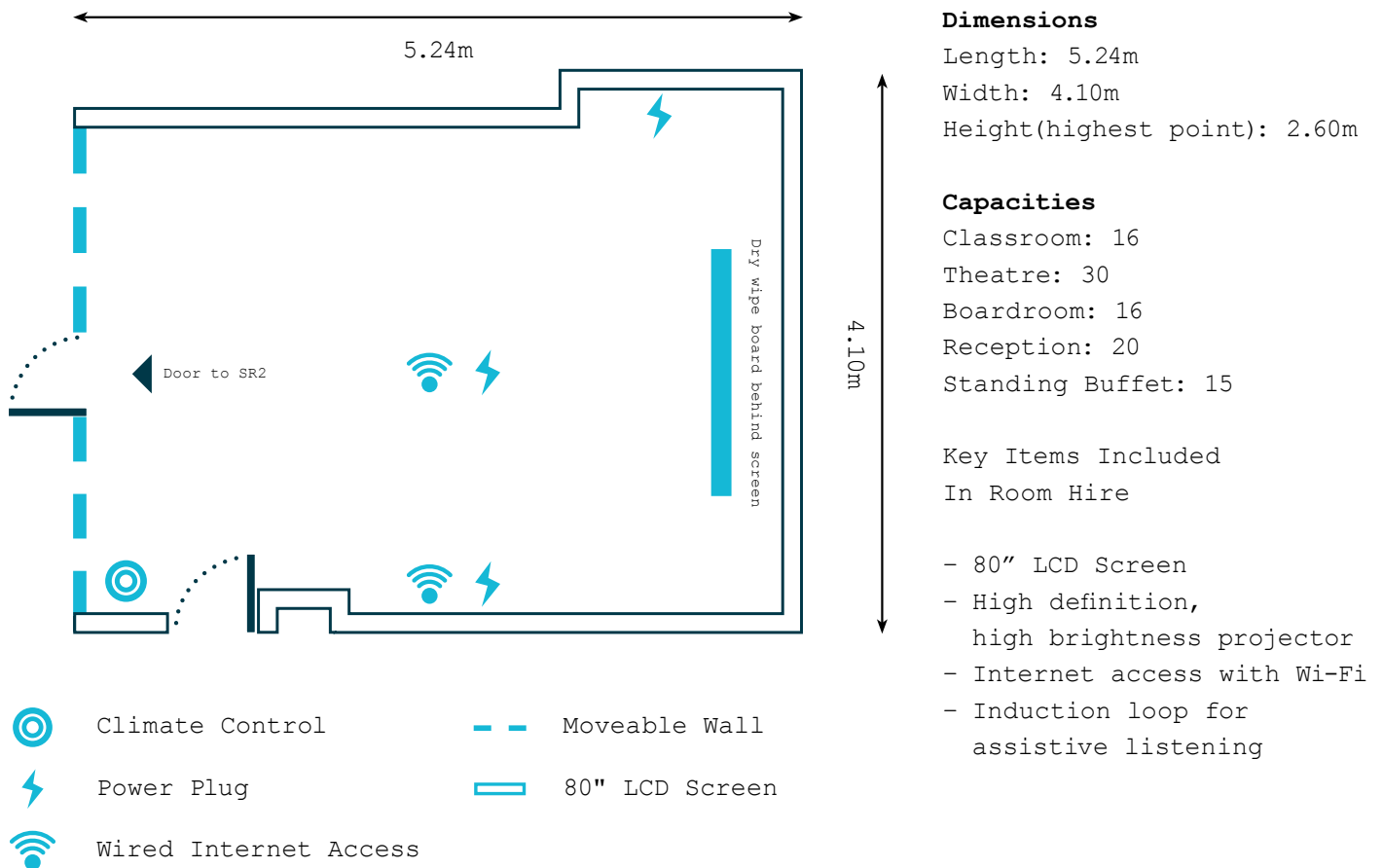



Room Guide:

The Wheatley Room

This unique, spacious, floor to ceiling booklined space is flooded with natural daylight. The room is based within the RSM's library, is air-conditioned and ideal for cabaret style meetings, presentations, training and away days. Refreshments are served at the rear of the room amongst the RSM's exhibition area.

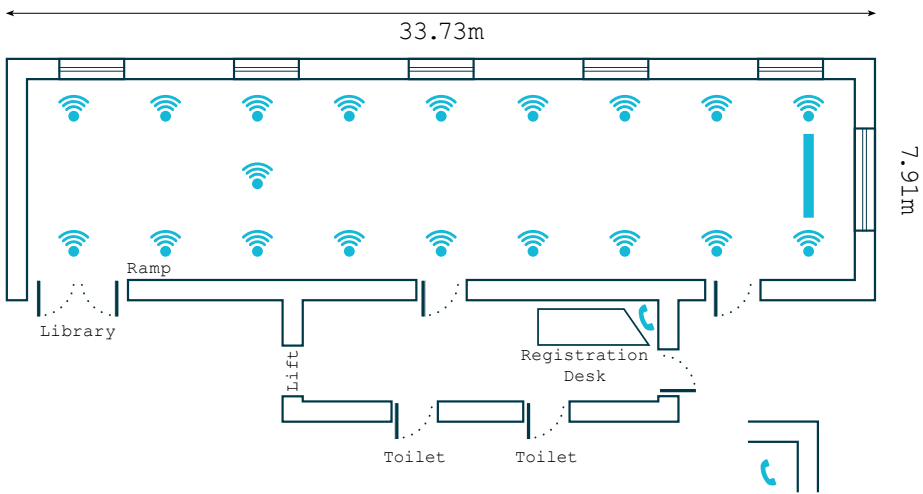

Dimensions

Length: 33.73m
 Width: 7.91m
 Height(highest point): 3.8m





Capacities

Theatre Style: 60
 Cabaret: 60
 Reception: 60
 Standing Buffet: 60
 Seated Buffet: 60
 Boardroom: 38
 U-shape and classroom: 40

Key Items Included

In Room Hire

- Internet access with WiFi

-  Wired Internet Access
-  Light Control
-  Phone
-  Glass Window
-  80" LCD Screen



Room Guide: Heritage Centre

The RSM's Heritage Centre is a unique meeting space set within the Library. The room houses a wealth of medical history from the RSM's archive, which is updated on a regular basis. The Heritage Centre can be hired out for meetings, training, presentations or away days.

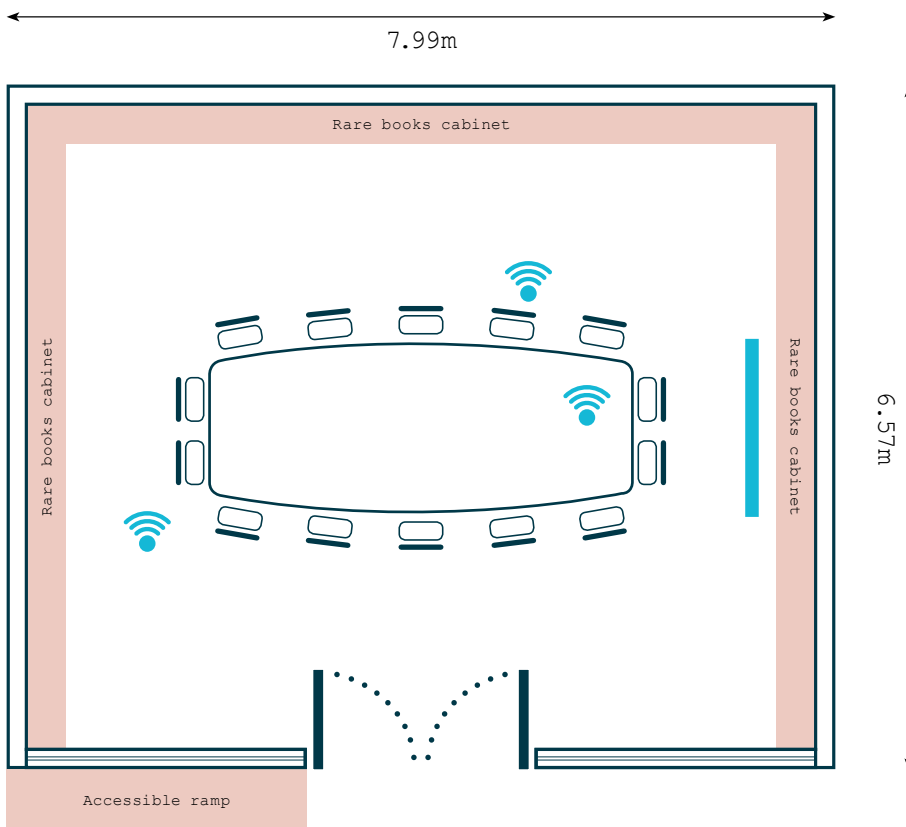

Dimensions

Length: 7.99m

Width: 6.57m



Height(highest point): 2.48m

Capacities

Boardroom: 14

Key Items Included
In Room Hire

- 48" Screen
- Polycon videoconference camera and soundbar
- Internet access with WiFi
- The temperature in the room is maintained at 20 degrees to protect the rare books in the glass cabinets.

-  48" LCD Screen
-  Wired Internet Access
-  Glass Window



Room Guide:

The Darwin Room

The Darwin room is a new designed contemporary and adaptable group working space. It has four chairs and a coffee table making it ideal for small meetings, interviews, collaborative and study sessions.

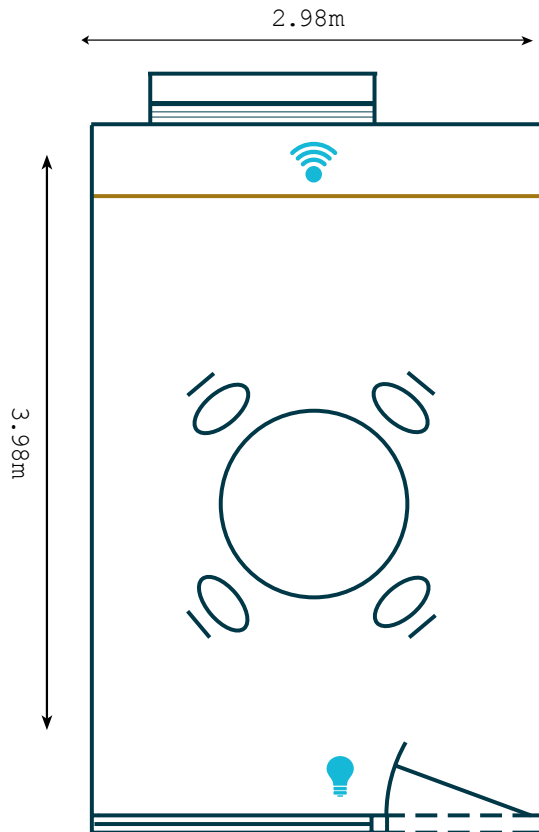

Dimensions

Length: 3.98m

Width: 2.60m

Height(highest point): 3.37m

Capacities

Boardroom: 4

Key Items Included

In Room Hire

- Internet access with WiFi



Wired Internet Access



Light Control



Phone



Glass Window



Room Guide: Jenner Room

The Jenner room is a new designed contemporary and adaptable group working space. It has six chairs and a coffee table making it ideal for small meetings, interviews, collaborative and study sessions.

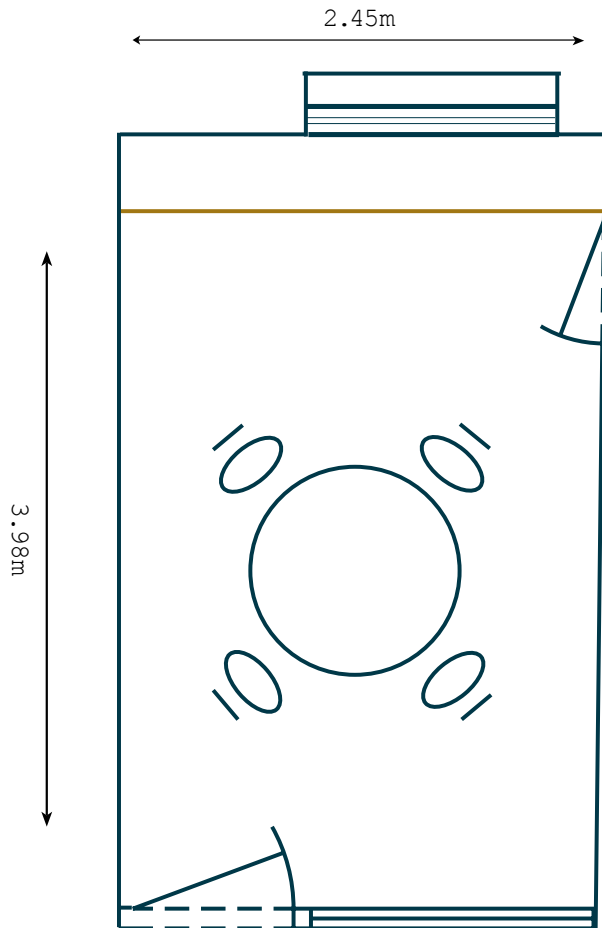

Dimensions

Length: 3.98m

Width: 2.45m

Height(highest point): 3.37m

Capacities

Boardroom: 4

Key Items Included
In Room Hire

- Internet access with WiFi



Wired Internet Access



Light Control



Phone



Glass Window



Room Guide: MacAlister Room

Located within the RSM's library this intimate boardroom is perfect for interviews, meetings, training, appraisals and workshops.

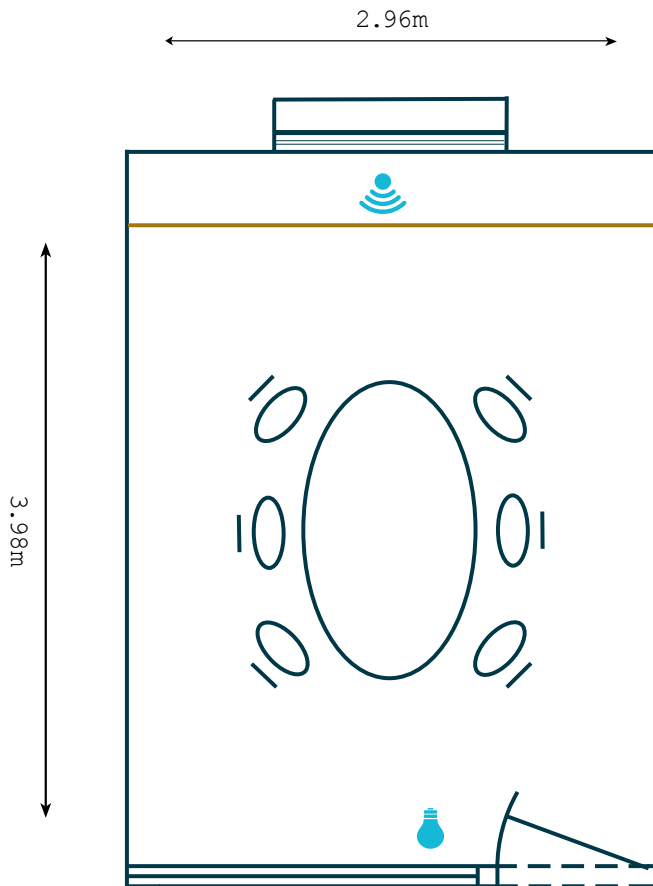

Dimensions

Length: 3.98m

Width: 2.96m

Height(highest point): 3.37m

Capacities

Boardroom: 6

Key Items Included

In Room Hire

- Internet access with WiFi
- TV
- Click & Share



Wired Internet Access



Light Control



Phone



Glass Window



Room Guide: Library Boardroom

Located on the 2nd floor this intimate boardroom is perfect for interviews, meetings, training, appraisals and workshops.

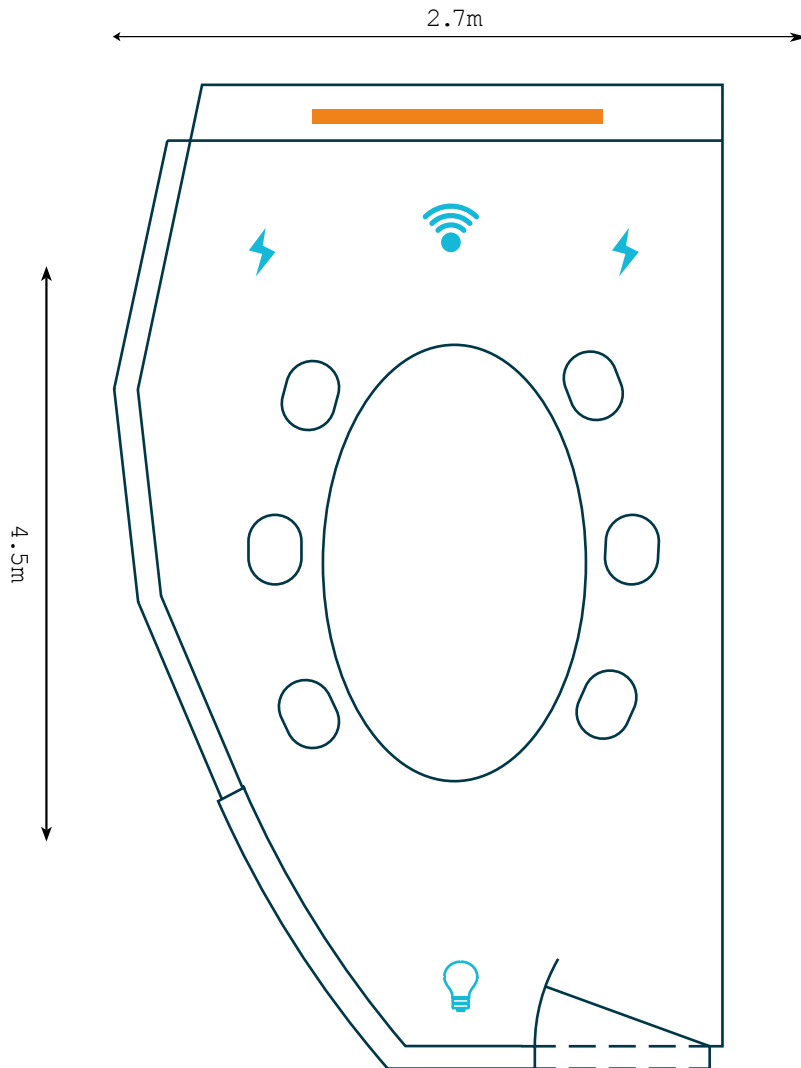

Dimensions

Length: 4.5m

Width: 2.7m

Height(highest point): 3m

Capacities

Boardroom: 6

Key Items Included
In Room Hire

- Internet access with WiFi
- TV
- Click & Share



Power Plug



Wired Internet
Access



Light



TV



Room Guide: Mezzanine Room

Localized on the mezzanine floor, this brand new room is perfect for small meetings, hold up to 40 guests.

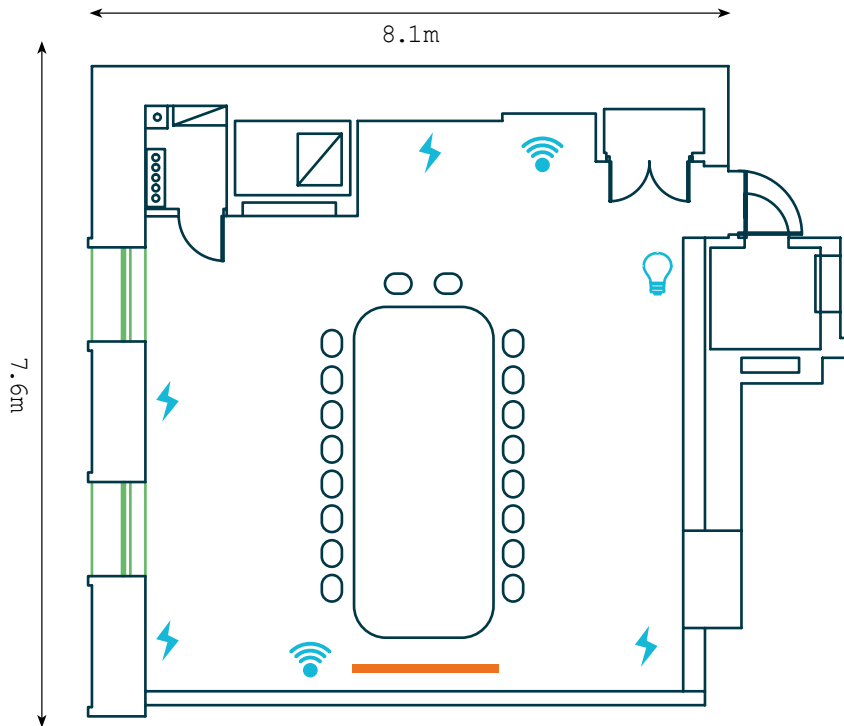

Dimensions:

Length: 7.6m

Width: 8.1m

Height (highest point): 2.25m

Capacities:

Boardroom: 20

Key Items Included in
Room Hire:

- TV
- Internet access with
Wi-Fi
- Click & Share



Power Plug



Glass Window



Wired Internet
Access



TV



Light



Room Guide:

Marcus Beck Library

A historical treasure of a room; dating back to 1912, once a research laboratory for the Medical Research Council, it's now home to the RSM's collection of rare medical books - making it one of the most distinctive meeting rooms in London. The unique horseshoe-shaped table, oak parquet floor, marble fireplace and air-conditioning make this room ideal for formal board meetings, presentations and training.

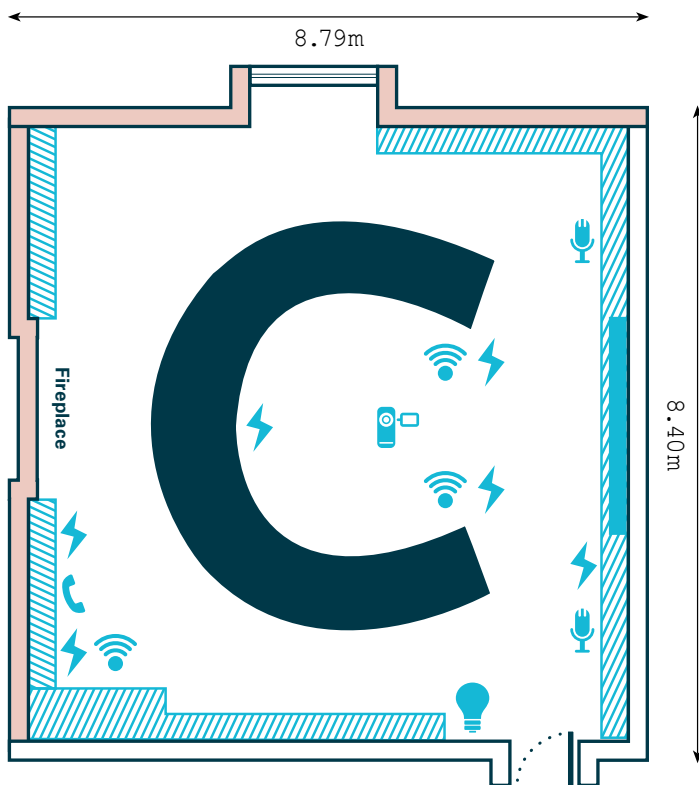

Dimensions

Length: 8.79m

Width: 8.40m









Height(highest point): 2.40m

Capacities

Boardroom: 30

Key Items Included
In Room Hire

- Hands-free conference phone
- 80" LCD screen
- Owl video conference cameras
- Internet access with Wi-Fi
- 'Clickshare' wireless presentation system
- Speakers for laptop audio

- | | |
|---|--|
|  Hands-Free Conference Phone |  Light Control |
|  Speaker |  Bookcase |
|  Power Plug |  80" LCD screen |
|  Wired Internet Access |  Glass Window |
|  Owl video conference cameras | |



Room Guide:

Louis Forman Room

This modern meeting room with a name bestowed by the Royal Society of Medicine, after an illustrious former president. The contemporary room is perfect for training sessions, board meetings and interviews. Naturally lit and air-conditioned with a permanent LCD screen and ClickShare connectivity.

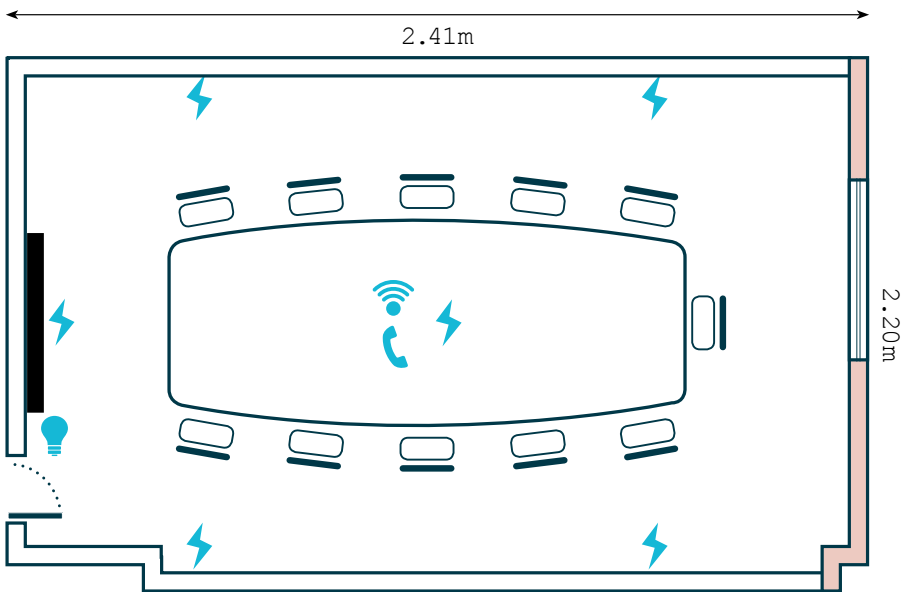

Dimensions

Length: 2.41m
Width: 2.20m
Height(highest point): 2.34m

Capacities

Boardroom: 11

Key Items Included
In Room Hire

- Hands-free conference phone
- HD display screen
- Internet access with Wi-Fi
- Barco ClickShare with Logitech camera/soundbar





Room Guide:

Chinese University of Hong Kong

This modern meeting room is sponsored by the Chinese University of Hong Kong. Perfect for business meetings, training and presentations, discreetly located on the third floor so you won't be disturbed by noise or other interruptions. Naturally lit and air-conditioned with a permanent LCD screen and ClickShare connectivity.

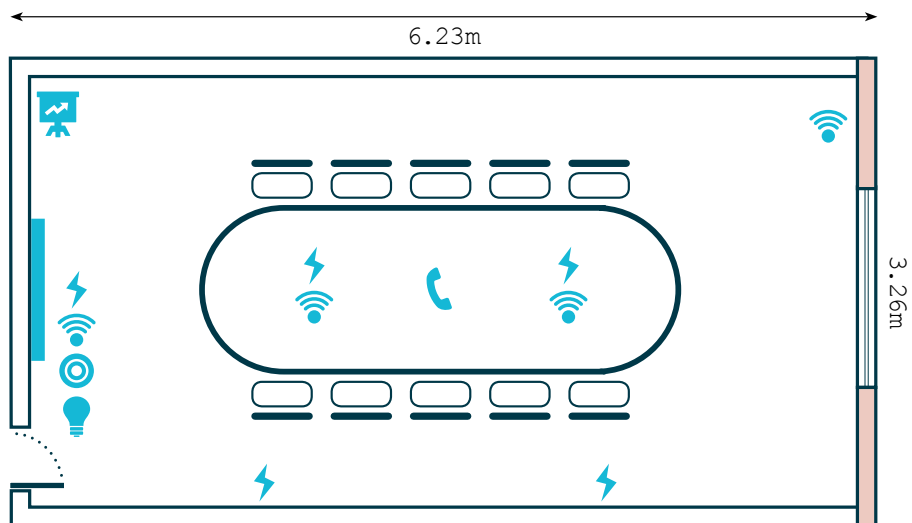

Dimensions

Length: 6.23m
Width: 3.26m
Height(highest point): 2.57m

Capacities

Boardroom: 10

Key Items Included In Room Hire

- HD display screen
- HD display screen with laptop audio
- Internet access with Wi-Fi
- Barco ClickShare with Logitech camera/soundbar

 Flip Chart

 Wired Internet Access

 Climate Control

 Light Control

 Hands-Free
Conference Phone

 LCD Screen

 Power Plug

 Glass Window



Room Guide: Henrietta

This spacious room is ideal for meetings and training with a permanent LCD screen and ClickShare connectivity for presentations and video conferencing. A popular room with natural lighting and the flexibility for multiple layouts, plus refreshments delivered directly to you.

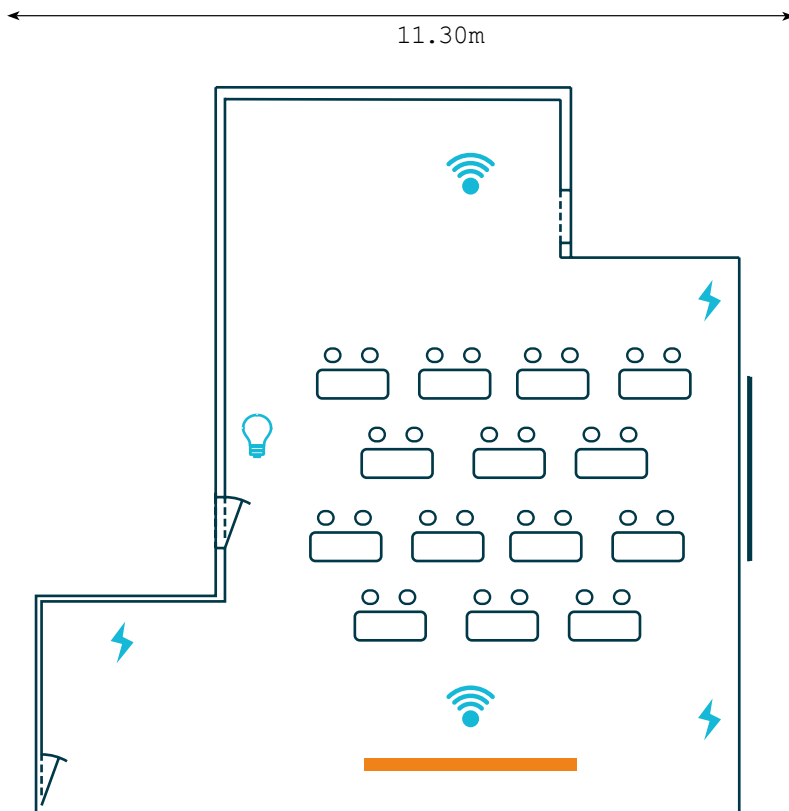

Dimensions:

Length: 11.45m
Width: 11.30m
Height (highest point): 2.9m
Screen size: 3.05 X 2

Capacities:

Classroom: 32
Theatre: 40
Boardroom: 30
Cabaret Style: 30
Reception: 40
Standing Buffet: 40

Key Items Included in Room Hire:

- TV
- Internet access with Wi-Fi
- Click & Share



Power Plug



Wired Internet Access



Light



TV



Room Guide:

Wigmore

A flexible meeting space with natural light for multi-purpose use, including presentations, board meetings and training. The room includes an LCD screen and ClickShare connectivity for video conferencing.

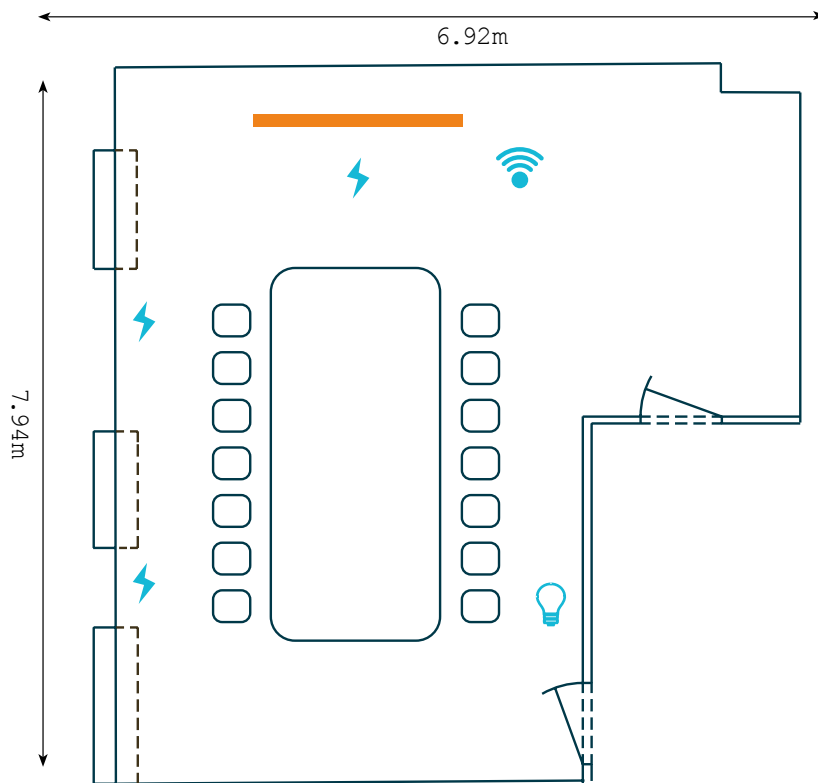

Dimensions:

Length: 7.94m

Width: 6.92m

Height (highest point): 2.65m

Screen size: 2.05 X 1.2

Capacities:

Classroom: 20

Theatre: 30

Boardroom: 14

Cabaret Style: 24

U Shape: 20

Standing Buffet: 30

Key Items Included in Room Hire:

- TV
- Internet access with Wi-Fi
- Click & Share



Power Plug



Wired Internet Access



Light



TV